

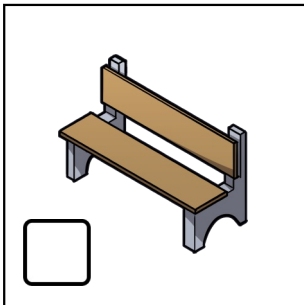

Dd

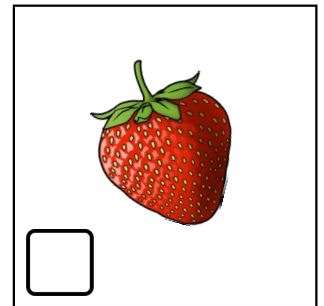
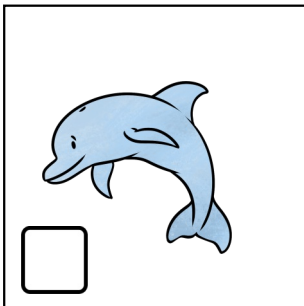

Höre genau hin!

Bei welchem Bild
hörst du den Laut?

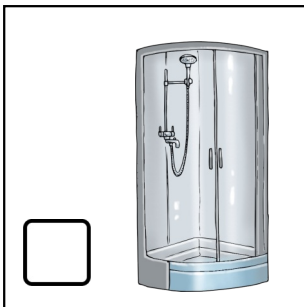
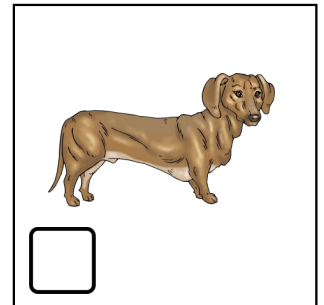

Kreuze an!

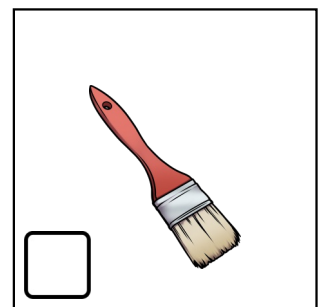
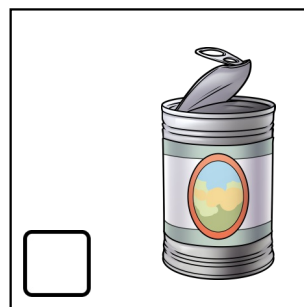
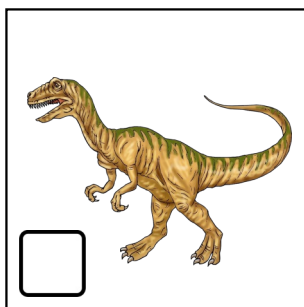
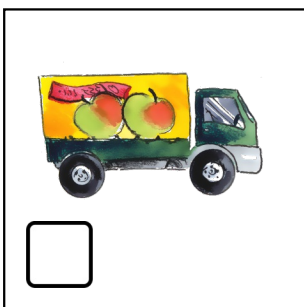
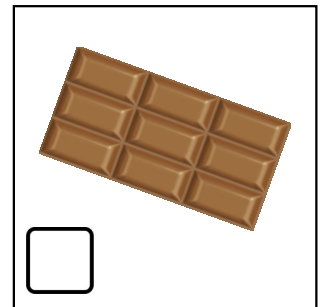

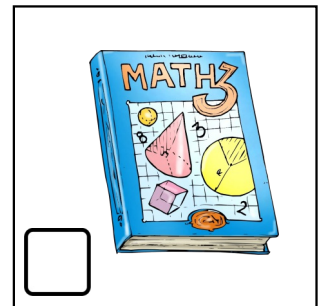
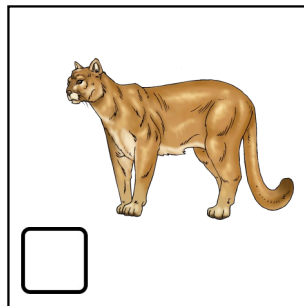
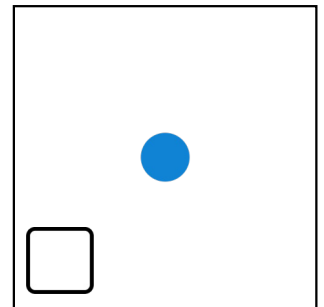
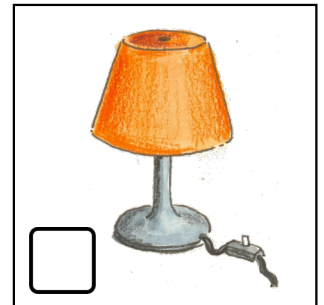
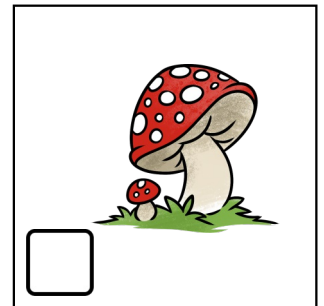
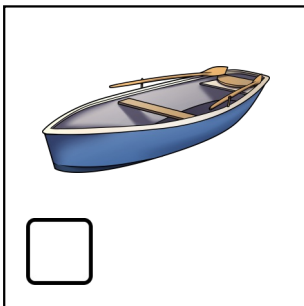
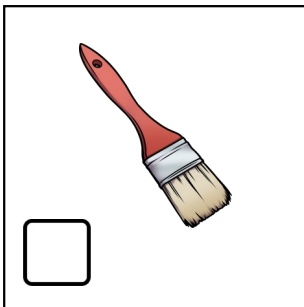
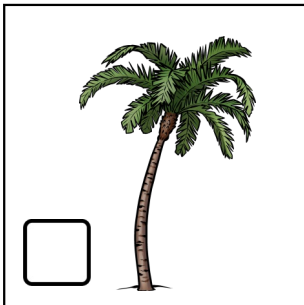
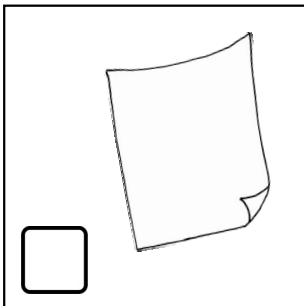
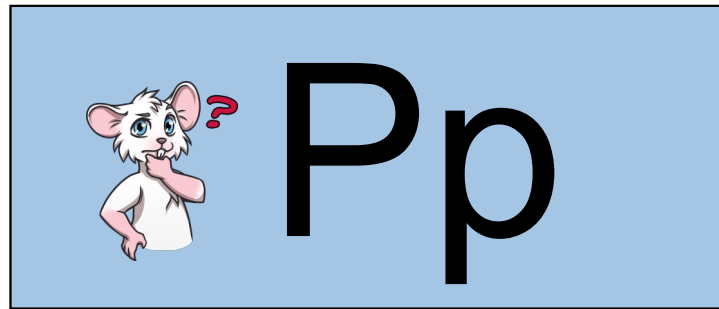

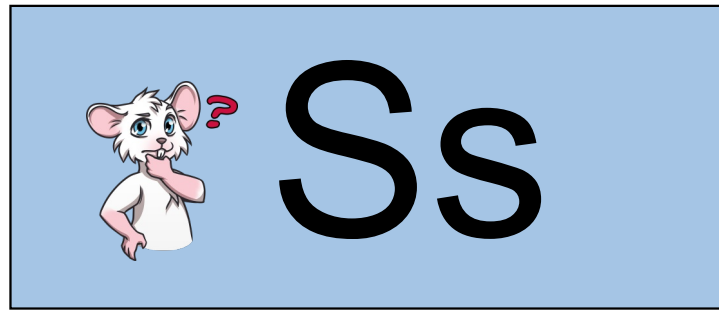

Lösung

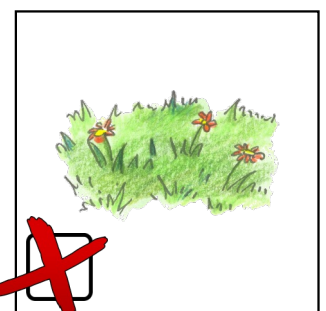
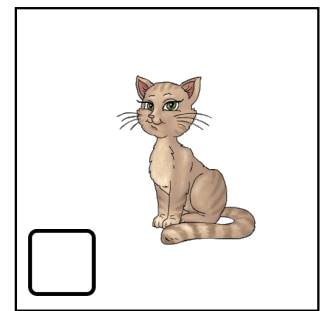
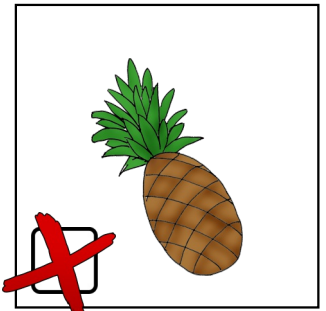
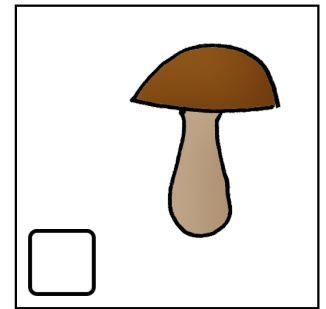
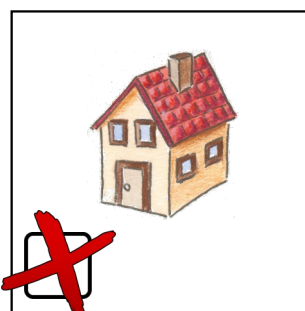
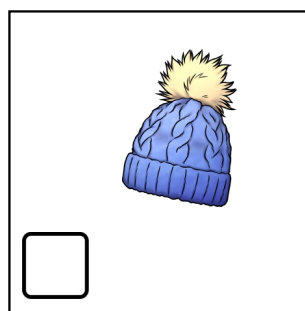
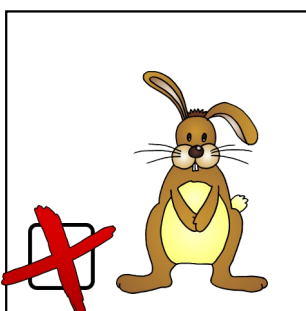
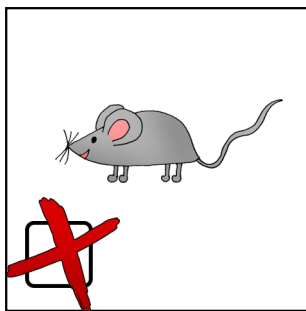
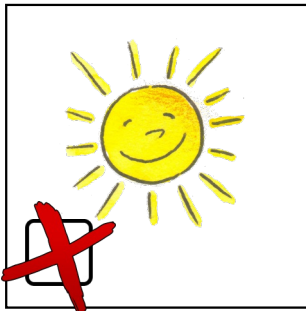
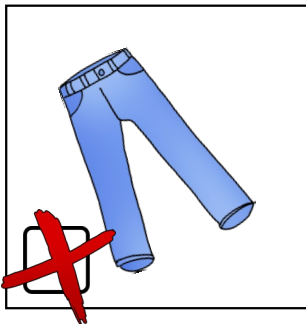

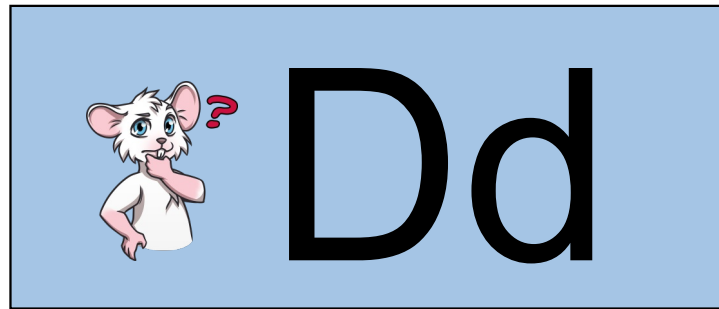

Lösung

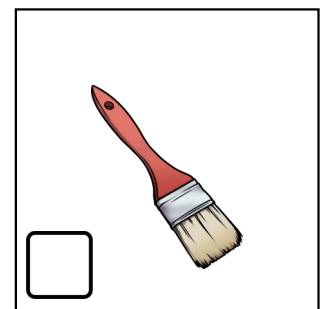
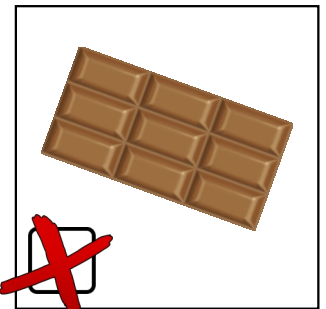
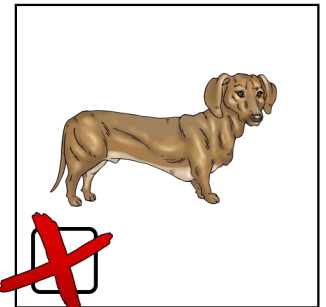
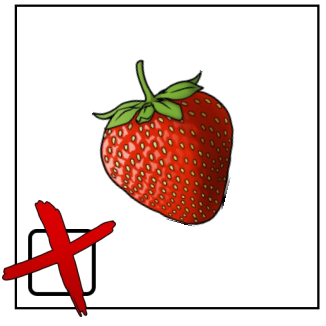
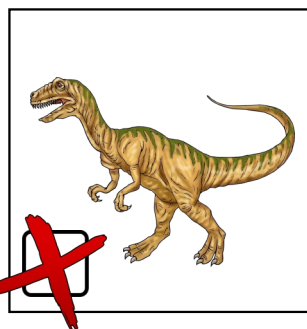
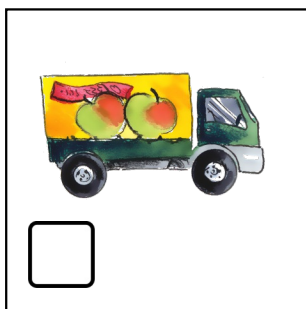
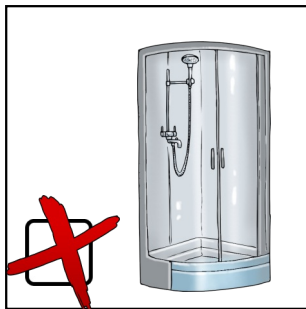
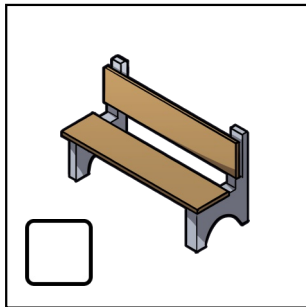
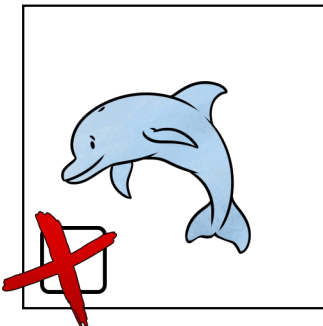

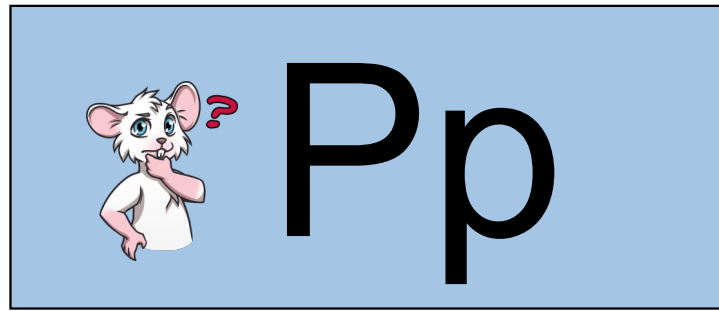

Lösung

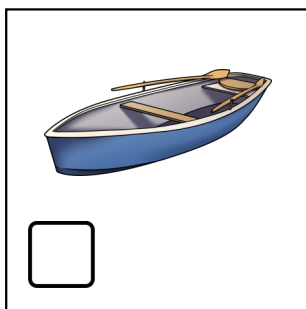
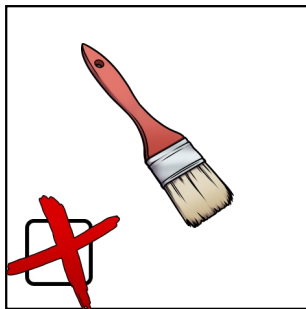
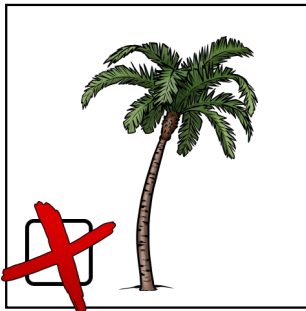
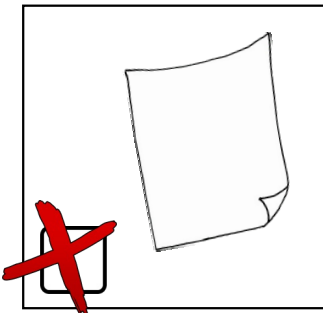

Höre genau hin!

Bei welchem Bild hörst du den Laut?

Kreuze an!

